

## GV-VD5700 5MP H.265 Low Lux WDR IR Vandal Proof IP Dome



- 1/1.8" progressive Low Lux CMOS
- Dual streams from H.265, H.264 or MJPEG
- Up to 30 fps at 2592 x 1944
- P-Iris for auto iris adjustment
- Vandal resistance (IK10 for metal casting)
- Ingress protection (IP67)
- Varifocal megapixel lens
- 3-axis mechanism (pan / tilt / rotate)
- Day/Night function (Removable IR-cut filter)
- External microphone
- Intelligent IR
- Two-way audio
- One sensor input and digital output
- Built-in micro SD card slot (SD/SDHC/SDXC, Class 10) for local storage
- DC 12V / PoE (IEEE 802.3af)
- Wide Dynamic Range (WDR)
- Defog
- Text overlay
- Tampering alarm
- 3D noise reduction
- IP address filtering
- Recording assigned by GV-Edge Recording Manager (Windows & Mac)
- Supports iPhone, iPad, Android & 3GPP
- 31 languages on Web interface
- ONVIF (Profile S) conformant

\* No Memory card slot & local storage function for Argentina.

### Introduction

GV-VD5700 is an outdoor camera for optimal day and night surveillance. GV-VD5700 can support H.265 video codec to achieve better compression ratio while maintaining high picture quality at reduced network bandwidths. For night operations, the camera allows up to 30 m (98.4 ft) IR effective distance. The camera also uses P-iris to produce images with better clarity and contrast. It is adjustable in 3 axis (pan, tilt and rotate).

### Active Tampering Alarm

Tampered



Focus Change

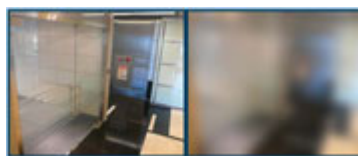

Camera Shift

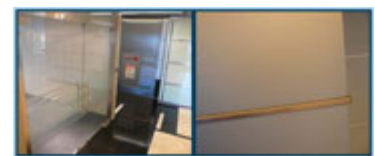

## Dimensions

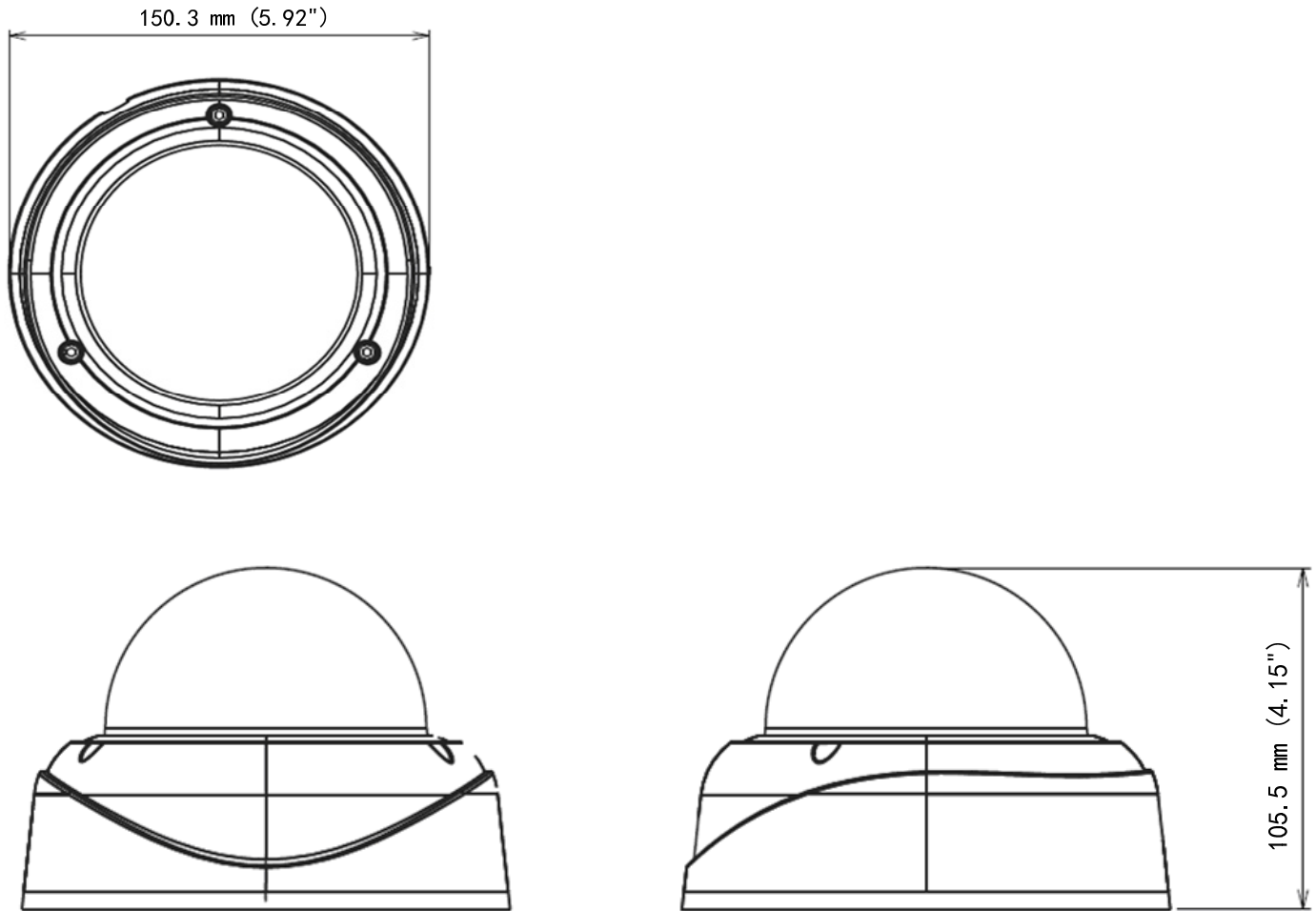

## Specifications

Camera		
Image Sensor	1/1.8" progressive scan CMOS	
Picture Elements	2592 (H) x 1944 (V)	
Minimum Illumination	Color	0.04 Lux
	B/W	0.03 Lux
	IR ON	0 Lux
Shutter Speed	Automatic, Manual (1/5 ~ 1/8000 sec.)	
White Balance	Automatic, Manual (2800K ~ 8500K)	
Gain Control	Automatic	
S/N Ratio	50 dB	
WDR	Yes	
Dynamic Range	72 dB	
BLC	Yes	
Lens		
Megapixel	Yes	
Day / Night	Yes (with removable IR-cut filter)	
Lens Type	Varifocal	
Focal Length	4 ~ 8 mm	
Maximum Aperture	F/1.65	
Mount	Ø 14 mm	
Image Format	1/1.8	
Horizontal FOV	88°~51°	
Operation	Focus	Manual (w / lock)

	Zoom	Manual (w / lock)
	Iris	P-Iris
Max. Torque (Focus/ Zoom Screws)		0.049 N.m
IR LED Quantity		12 IR LEDs
Max. IR Distance		30 m (98.4 ft.)
<b>Operation</b>		
Video Compression		H.265, H.264, MJPEG
Video Stream	Stream 1	H.265 or H.264
	Stream 2	H.265, H.264 or MJPEG
Frame Rate		30 fps at 2592 x 1944 * The frame rate and the performance may vary depending on the number of connections and data bitrates (different scenes).
Image Setting		Brightness, Contrast, Saturation, Sharpness, Gamma, White Balance, Flicker-less, Image Orientation, Shutter Speed, Backlight Compensation, D/N Sensitivity, WDR, Defog, Low Lux Enhancement, Denoise, Metering
Audio Compression		G.711
Audio Support		Two-way audio
Sensor Input		1 Input (dry contact)
Alarm Output		1 Output (200 mA 5V DC)
<b>Video Resolution</b>		
Main Stream	4:3	2592 x 1944, 2048 x 1536, 1600 x 1200, 1280 x 960, 640 x 480
	16:9	2592 x 1520, 2304 x 1296, 1920 x 1080, 1280 x 720, 640 x 360
	5:4	1280 x 1024, 640 x 512
Sub Stream	4:3	640 x 480, 320 x 240
	16:9	640 x 360, 448 x 256
	5:4	640 x 512, 320 x 256
<b>Network</b>		
Interface		10/100 Ethernet
Ethernet Protocol		DHCP, DynDNS, FTP, HTTP, HTTPS, NTP, ONVIF (Profile S), PSIA, QoS (DSCP), RTSP, SNMP, SMTP, TCP, UDP, UPnP, 3GPP/ISMA
<b>Mechanical</b>		
Temperature Detector		Yes
Camera Angle Adjustment	Pan	0° ~ 360°
	Tilt	90° ~ 180°
	Rotate	0° ~ 355°
Connectors	Power	2-pin terminal block, PoE
	Ethernet	Ethernet (10/100 Base – T), RJ-45
	Audio	1 In (2-pin terminal block for microphone) 1 Out (2-pin terminal block for speaker)
	Digital I/O	4-pin terminal block
	Local Storage	Micro SD card slot (SD/SDHC/SDXC, Class 10) * <b>SUHS-II</b> card type is not supported.
LED Indicator		2 LEDs: Power, Status
<b>General</b>		
Environment Temperature	Start-up	-20 °C ~ 50 °C (-4 °F ~ 122 °F)
	Operation	-30 °C ~ 50 °C (-22 °F ~ 122 °F)
Humidity		10% to 90% (no condensation)
Power Source		12V DC / PoE (IEEE 802.3af)
Max. Power Consumption		12.6 W
Dimensions		∅ 150.3 x 105.5 mm (5.92" x 4.15")
Weight		800 g (1.76 lb)
Ingress Protection		IP67
Vandal Resistance		IK10 for metal casing
Regulatory		CE, FCC, RCM, LVD, RoHS compliant
<b>Power over Ethernet</b>		
PoE Standard		PoE (IEEE 802.3af Power over Ethernet / PD)
PoE Power Supply Type		End-Span

PoE Power Output	Per Port 48V DC, 350 mA. Max. 15.4 watts
<b>Web Interface</b>	
Installation Management	Web-based configuration
Maintenance	Firmware upgrade through Web Browser or Utility
Access from Web Browser	Camera Live View, Video Recording, Change Video Quality, Bandwidth Control, Image Snapshot, Audio, Picture in Picture, Picture and Picture, Privacy Mask, Text Overlay, Visual Automation, Tampering Alarm, Digital PTZ
Language	Arabic / Bulgarian / Czech / Danish / Dutch / English / Finnish / French / German / Greek / Hebrew / Hungarian / Indonesian / Italian / Japanese / Lithuanian / Norwegian / Persian / Polish / Portuguese / Romanian / Russian / Serbian / Simplified Chinese / Slovakian / Slovenian / Spanish / Swedish / Thai / Traditional Chinese / Turkish
<b>Applications</b>	
Network Storage	GV-Backup Center, GV-VMS
Smart Device Access	GV-Eye for iOS and Android
Live Viewing	Browser (IE, Chrome, Firefox, Safari), Mobile app
CMS Server support	GV-Control Center, GV-Center V2, GV-Vital Sign Monitor

**Note:**





- Do not use clothes or any ordinary material to clean the camera cover since they may result in scratches.
- Specifications are subject to change without notice.
- Mind the following when using a memory card for recording:
  - Recorded data on the memory card can be damaged or lost if the data are accessed while the camera is under physical shock, power interruption, memory card detachment or when the memory card reaches the end of its lifespan. No guarantee is provided for such causes.
  - The stored data can be lost if the memory card is not accessed for a long period of time. Back up your data periodically if you seldom access the memory card.
  - Memory cards are expendable and their durability varies according to the conditions of the installed site and how they are used. Back up your data regularly and replace the memory card annually.
  - To avoid power outage, it is highly suggested to apply a battery backup (UPS).
  - For better performance, it is highly suggested to use Micro SD card of MLC NAND flash, Class 10.
  - Replace the memory card when its read/write speed is lower than 6 MB/s or when the memory card is frequently undetected by the camera.
- To use the GV-Eye application, change the video codec setting to H.264 for the GV-IP CAM H.265 models.

**Packing List**

- |                                     |                                 |
|-------------------------------------|---------------------------------|
| 1. H.265 Vandal Proof IP Dome       | 10. Anti-Drop Wire              |
| 2. Torx Wrench                      | 11. Screw for Anti-Drop Wire    |
| 3. Silica Gel Bag x 2               | 12. Pan Angle Notification Card |
| 4. Sticker (for Silica Gel Bag) x 2 | 13. Installation Sticker        |
| 5. Screw Anchor x 4                 | 14. RJ45 Connector x 2          |
| 6. Long Screw x 4                   | 15. GV-IPCAM Software DVD       |
| 7. Back Plate                       | 16. GV-Software DVD             |
| 8. Short Screw for Back Plate x 3   | 17. Warranty Card               |
| 9. Cable Stopper                    |                                 |

## Accessories

Model No.	Name		Details
GV-Mount100	Straight Tube and Junction Box Kit		Dimensions: 200 x 170 x 257.5 mm (7.9" x 6.7" x 10.1") Weight: 3.17 kg (6.99 lb)
GV-Mount101	Straight Tube Kit		Dimensions: 219 x 125 x 332 mm (8.6" x 4.9" x 13.1") Weight: 1.8 kg (3.97 lb)
GV-Mount200	Wall Pendant Tube		Dimensions: 225 x 140 x 250 mm (8.9" x 5.5" x 9.8") Weight: 900 g (1.98 lb)
GV-Mount203	Wall Pendant Tube and Junction Box Kit		Dimensions: 315 x 195.5 x 225 mm (12.4" x 7.7" x 8.9") Weight: 2.95 kg (6.5 lb)
GV-Mount206	Wall Mount Bracket Kit		Dimensions: 126.5 x 211.3 x 176.85 mm / 5 x 8.3 x 6.96" (L x W x diameter) Weight: 0.93 kg (2.06 lb)
GV-Mount300	Convex Corner Adapter Kit		Dimensions: 238.6 x 409.5 mm (9.4" x 16.1") Weight: 4.27 kg (9.41 lb)
GV-Mount310	Concave Corner Adapter Kit		Dimensions: 123.3 x 393.1 mm (4.9" x 15.5") Weight: 2.96 kg (6.53 lb)
GV-Mount400	Pole Mount Bracket Kit (Ø 4" ~ 6")		Bracket: 241 x 161 mm (9.5" x 6.3") Weight: 1.70 kg (3.75 lb) Steel Strap Diameter: Ø 4" ~ 6"

Model No.	Name		Details
GV-Mount410	Pole Mount Bracket Kit (Ø 6" ~ 7.5")		Bracket: 241 x 161 mm (9.5" x 6.3") Weight: 1.70 kg (3.75 lb) Steel Strap Diameter: Ø 6" ~ 7.5"
GV-Mount702	Extension Tube		Four options are available. Dimensions: Ø 5.4 x 10 or 20 or 30 or 50 cm (Ø 2.1" x 3.9" or 7.9" or 11.8" or 19.7") Weight: 180 g or 390 g or 550 g or 800 g (0.4 lb or 0.86 lb or 1.21lb or 1.76 lb)
GV-Mount903	GV-VD Series Dome Housing		Dimensions: Ø 186 x 97.5 mm (Ø 7.3" x 3.8") Weight: 600 g (1.32 lb)
GV-PA191	Power over Ethernet (PoE) Adapter		The GV-PA191 is a Power over Ethernet (PoE) adapter designed to provide power to the IP device through a single Ethernet cable.
GV-Relay V2	GV-Relay V2		The GV-Relay V2 is designed to expand the voltage load of GV IP devices. It provides 4 relay outputs, and each can be set as normally open (NO) or normally closed (NC) independently as per your requirement.
GV-POE Switch	GV-POE Switch		The GV-POE Switch is designed to provide power along with network connection for IP devices. The GV-POE Switch is available in various models with different numbers and types of ports.
Power Adapter	Contact your sales representative for the countries and areas supported.		